

Data Sheet



Article number: 20100008B

Description: E+G
Side thrust pin GN 714-10-50

Measures

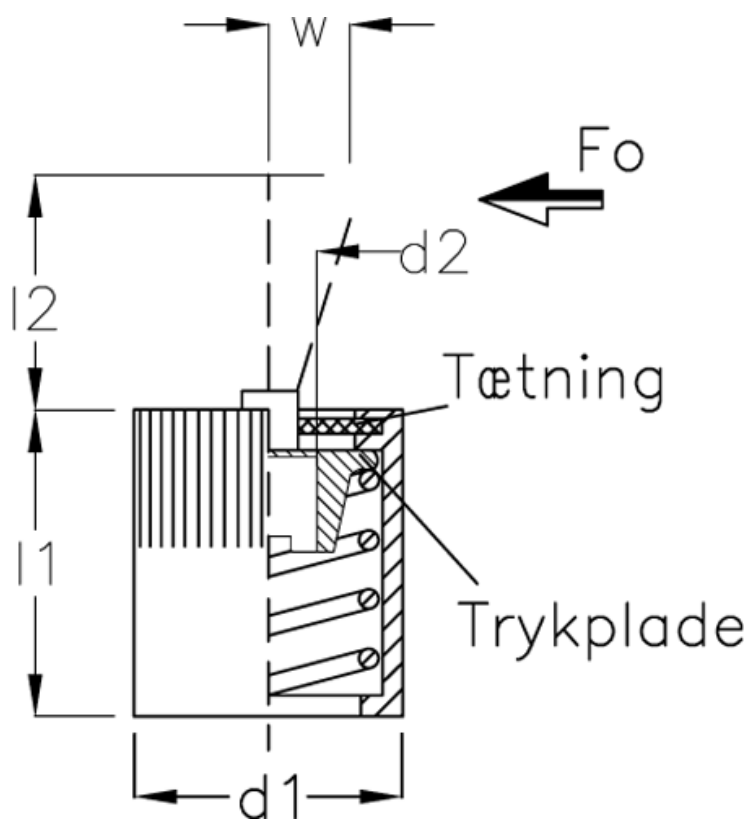

d1	= 10
d2	= M4
d3	= 10
H	= 12
l1	= 12
l2	= 4.0
screw driver	= GN 715.1-5
Side power N at l2 = 50	

W = 1.6